

Green Innovators of Innovation

New micro size drive
of LS Industrial Systems

STARVERT *iE5*

Optimum solution for small size motor control

0.1~0.4kW 1Phase 200~230Volts
0.1~0.4kW 3Phase 200~230Volts



Drive Solution



LS Industrial Systems
www.lsis.biz

Experience the power!



04 Key features of product

06 Model and Specifications

07 Standard Specification

08 Wiring

09 Terminal and loader functions

10 Shifts between each code and group

12 Function code table

18 Protections

19 Check & Remedy

20 Peripheral device Specifications

21 Dimension

Small but Powerful!

We have created the Micro class drive to provide the optimal solution for small size motor controls.

You will be experiencing amazing power with this slim size.



Slim and variety!

Our iE5 is best fit for small machineries
such as packing machines, small conveyers, treadmills and etc...



Smaller micro size

Our iE5 realizes 5% smaller micro size comparing to previous product.

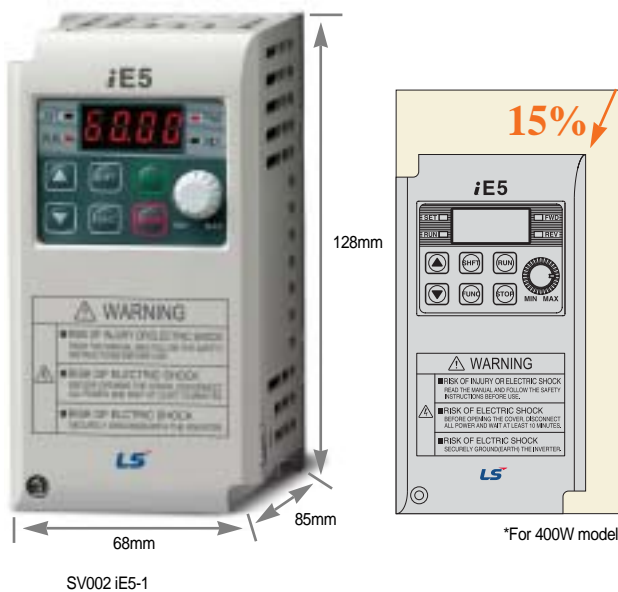

Easy operation and control

The operation became easy by adopting the 6 keys and volume resistor types on the loader. Besides, convenience is guaranteed by limiting the total number of parameters as 100 parameters.

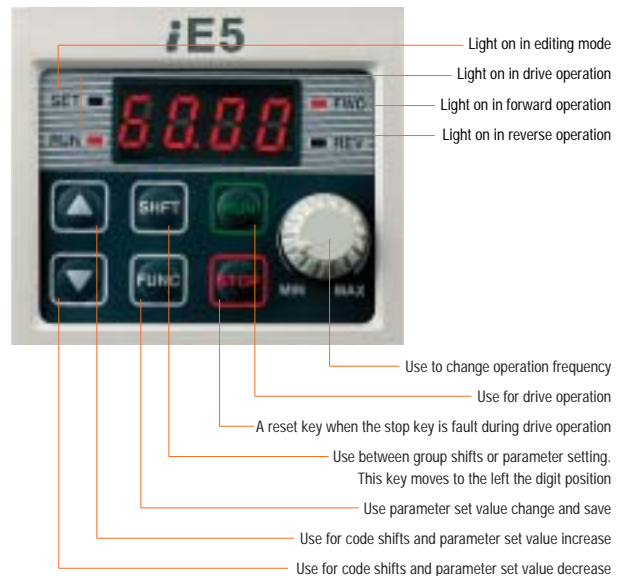



PI Control

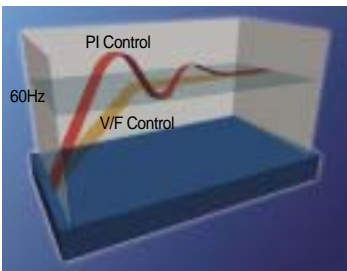

The PI Control is used to control the oil level, temperature and pressure of plant and process. This drive speed control function compares between drive setting value and signal values gauged from sensors and actual control is made through Proportion and Integral.

PNP, NPN dual control Signal

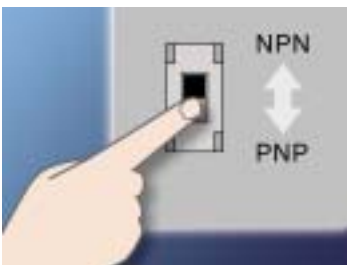

iE5 provides both PNP and NPN minor signal powers so that no matter what signal type the external controller adopts, +24V power can be applied.

Modbus communication interface (optional)

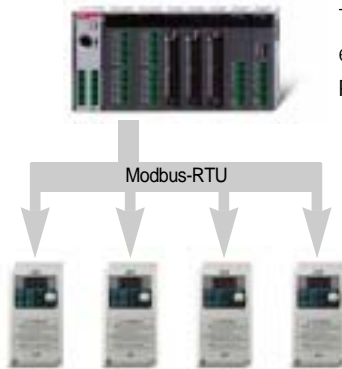

The optional modbus communication enables controlling drives through PLC and other controlling devices.

Parameter copy function (Under development)



The parameters inputted to a drive can be duplicated and copied to other drives by this parameter copy unit.



Model and Specifications

Motor	220V/Single phase	220V/3 phase
0.1kW(1/8HP)	SV001 iE5-1	SV001 iE5-2
0.2kW(1/4HP)	SV002 iE5-1	SV002 iE5-2
0.4kW(0.5HP)	SV004 iE5-1	SV004 iE5-2

C : RS-485 communication is available as option
 - : RS-485 communication is not available

Input voltage 1 : Single 220V class
 2 : 3Phase 220V class

SV 004 iE5 1 C

- LS Inverter Starvert series
- Maximum motor capacity(kW)
(001 : 0.1kW ~ 004 : 0.4kW)
- LS Inverter series name

SV004iE5-1		Inverter model
INPUT	200 ~ 230V 1phase 5.5A 50/60Hz	Input voltage specification
OUTPUT	0 ~ INPUT V 3phase 2.5A 0.1~200Hz 0.5HP/0.4kW (D)	Output voltage, Rated output current, Frequency, Inverter capacity
 0010222100155		Barcode and serial number
LS Industrial Systems Co., Ltd. Made in Korea		

Standard Specification

Basic specification

Model : SV		iE5-	001-1	002-1	004-1	001-2	002-2	004-2
Applicable motor		[HP]	1/8	1/4	1/2	1/8	1/4	1/2
		[kW]	0.1	0.2	0.4	0.1	0.2	0.4
Rated output	Rated capacity [kVA]		0.3	0.6	0.95	0.3	0.6	1.14
	Rated current [A]		0.8	1.4	2.5	0.8	1.6	3.0
	Output frequency [Hz]		0 ~ 200 [Hz]					
	Output voltage [V]		3 phase 200 ~ 230V					
Rated input	Applicable voltage [V]		1 phase 200 ~ 230 VAC (± 10%)			3 phase 200 ~ 230 VAC (± 10%)		
	Input frequency [Hz]		50 ~ 60 [Hz] (± 5%)					
	Rated current [A]		2.0	3.5	5.5	1.2	2.0	3.5

Control

Control type	V/F Control
Frequency set resolution	Digital command : 0.01Hz Analog command : 0.06Hz (Max.frq : 60Hz)
Frequency accuracy	Digital command : 0.01% of Max. Output frequency Analog command : 0.1% of Max. Output frequency
V/F pattern	Linear, Squared, User V/F
Overload capacity	150% / 1Min
Torque boost	Manual / Auto torque boost

*Note1) The standard of rated capacity is 220V.

*Note2) The maximum output voltage does not increase over input voltage and the output voltage can be set below input voltage level.

Operation

Operation method	Operation method can be selected between loader, terminal and communication operation	
Frequency set	Analog method : 0~10(V), 0~20(mA), Loader volume Digital method : Loader	
Operation function	PI Control, Up-Down , 3-wire operation	
Input	Multi-function terminal (5 points) P1,P2,P3, P4,P5	NPN / PNP Selectable FWD/REV operation, Fault reset, Jog operation, Multi-step frequency(up/down), DC braking in stop mode, Frequency increase, Frequency decrease, 3 wire-operation external trip A and B, Shift to general operation from PI operation. Analogue command frequency set, Up/down save frequency delete
	Multi-function relay terminal	Fault and drive operation condition output (N.) (N.C) AC250V below 0.3A and below DC 30V 1A
	Analogue output	0~10Vdc(below 10mA) : can be selected among frequency, current, voltage, DC voltage

Protection

Trip	Over voltage, Under voltage, Over current, Ground fault, Drive overload, Overload trip, Overheat, Condensor overload, Phase loss overload protection, Frequency command loss, Hardware fault
Alarm	Stall prevention
Momentary power loss	Below 15msec : Operation continued (should be within rated input voltage and rated output) Over 15msec : Auto re-ignition operation.

Guaranteed operation condition

Cooling	Open cooling
Enclosure	IP20 (open type)
Ambient temperature	-10 ~65
Protection temperature	-20 ~ 65
Humidity	Below 90% RH (non-condensation)
Altitude/Vibration	Below 1000m, 5.9m/sec square (0.6G)
Installation condition	No corrosive gas, No flammable gas, No oil mist, No dust

Wiring

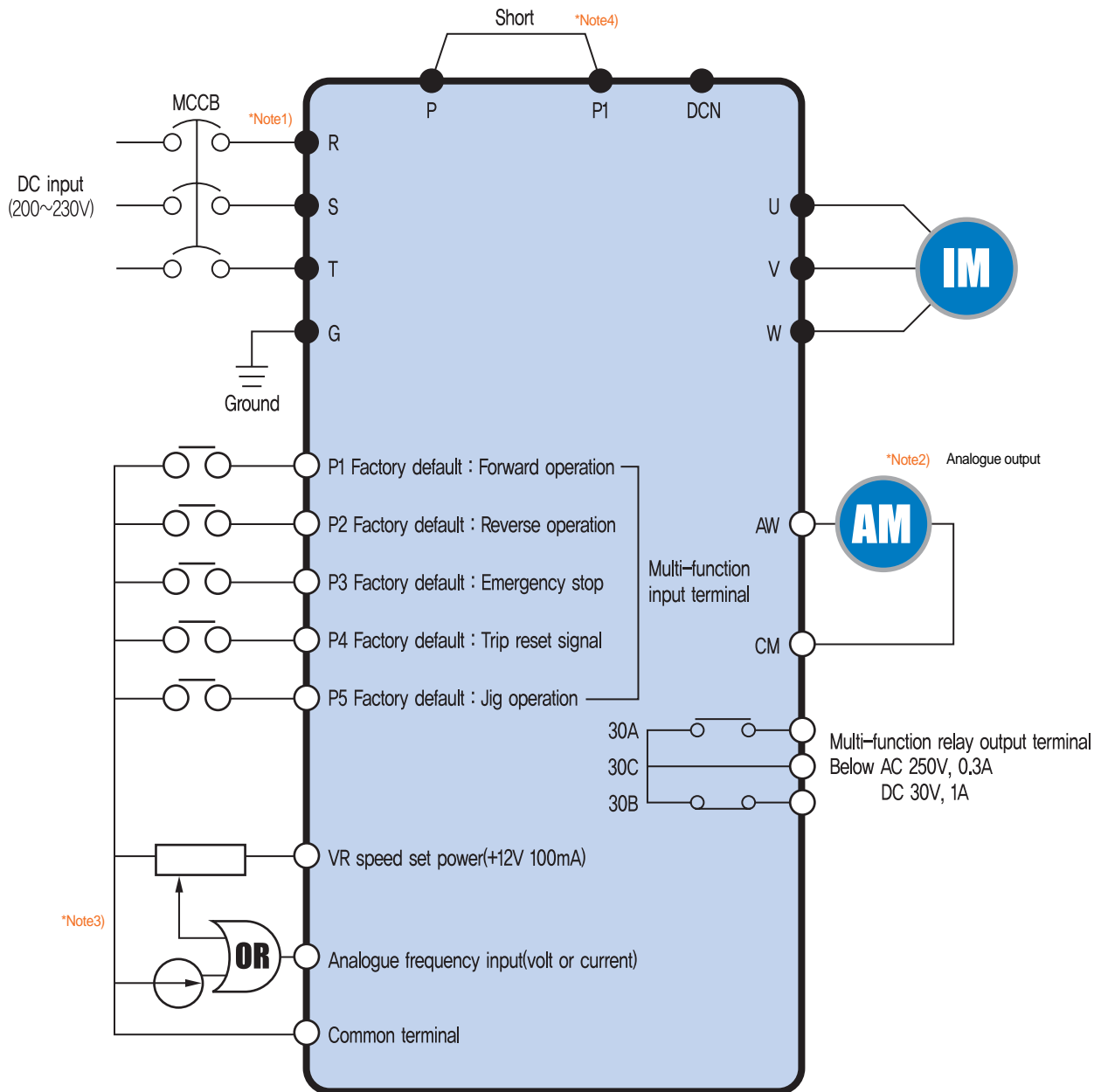

***Note1)** "and" means the main circuit and the control circuit respectively.
Please connect to the R and S terminals in case of single phase use.

***Note2)** The analogue output is from zero to 10V.

***Note3)** The voltage current and loader volume is possible for the external speed command.

***Note4)** The P and P1 terminals for DC reactor are connected as short circuit.

Terminal Function



	Terminal signal	Terminal name	Description
Main circuit	R, S, T	DC input	Connect 3 phase AC power
	U, V, W	Inverter output	Connect 3 phase induced motor
	P, P1	DC reactor connection	Connect DC reactor.
	G	Ground	Ground connection terminal

*Note) Please connect to the R and S terminals for single phase drive.



Classification	Terminal signal	Terminal name	Description
Input signal	P1, P2, P3, P4, P5	Multifunction input terminal	Factory default value P1 (FX : forward operation) P2 (RX : Reverse operation) P3 (EST : Emergency stop) P4 (RST : Trip clear signal) P5 (JOG : Jog frequency operation)
	VR	Frequency set power	Analog frequency set power. Max, output is +12V 100mA.
	AI	Frequency set(Volt/Current)	DC 0~10V and DC 4~20mA can be set as basic frequency.
	CM	Frequency set common terminal	Analog frequency set signal and AM common terminal.
Output signal	AM-CM	Display	Among output frequency, output current and output voltage, one item can be selected as output. Factory set is output frequency. Max output voltage is 0~10V. (Below 10mA)
	30A, 30C, 30B	Multifunctional relay	Inverter protection function is activated as blocking the output and releasing multifunction signal. AC 250V below 0.3A and below DC 30V 1A.

Loader Function



Classification	Display	Function	Function description
LED	FWD	Forward	Light is on with forward operation.
	REV	Reverse	Light is on with reverse operation.
	SET	On setting	Light is on when parameter is being set.
	RUN	On operation	Light is off when the inverter is on Acc/Dcc and on with normal speed operation.
KEY		Up key	For code shift or increasing parameter set value.
		Down key	For code shift or decreasing parameter set value.
	RUN	Operation key	For inverter operation
	STOP	Stop/Reset	Stop command key during operation and also used as fault clear key.
	FUNC	Function key	Used for changing parameter set value and saving its value
	SHFT	Shift key	Shift between groups and parameter setting or moving digit number to the left.
		Volume resistor	For changing operation frequency.
		NPN/PNP selection switch	Turning to either NPN or PNP mode.
		Current/Voltage selection switch	Switch for transforming the analog switch inputs into current or voltage.



Shifts between each code and group

Diagram of function code shift method



The parameter group of iE5 consists of below two groups

Group name	Content
Operation group	Basic parameters for operation such as the Target frequency, Acc/Dec time and etc.
Program group	Additional function set parameter

Shifts between groups can be enabled pressing the shift key at the zero code of the operation and program groups.

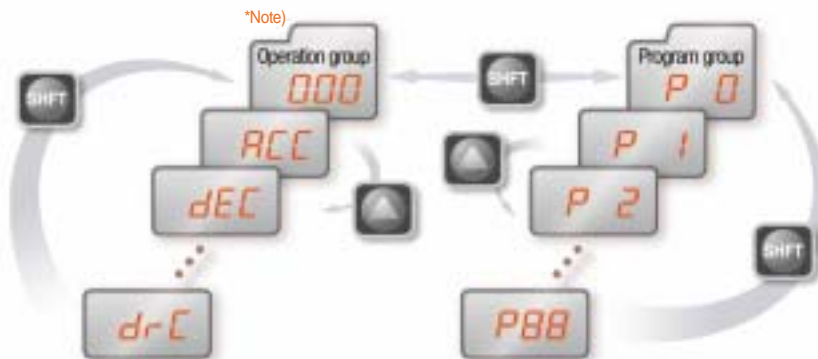

**Note)* The target frequency can be set at the first group of operation group so that the factory default value has been set as 0.0 yet in case of frequency change, the changed frequency is displayed.

If a user presses the shift key out of number 0, the activating parameter shifts to 0 and if the user presses once more the shift key can be shifted between groups.

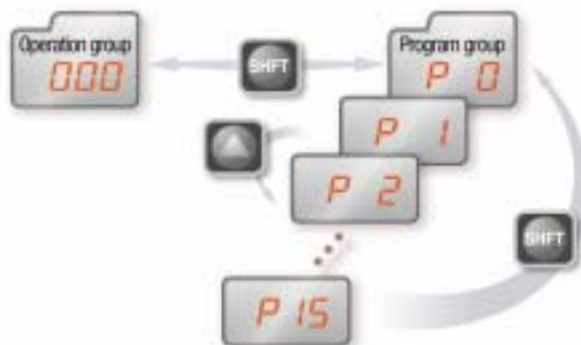

Shifts between each code and group

Operation group code shifts

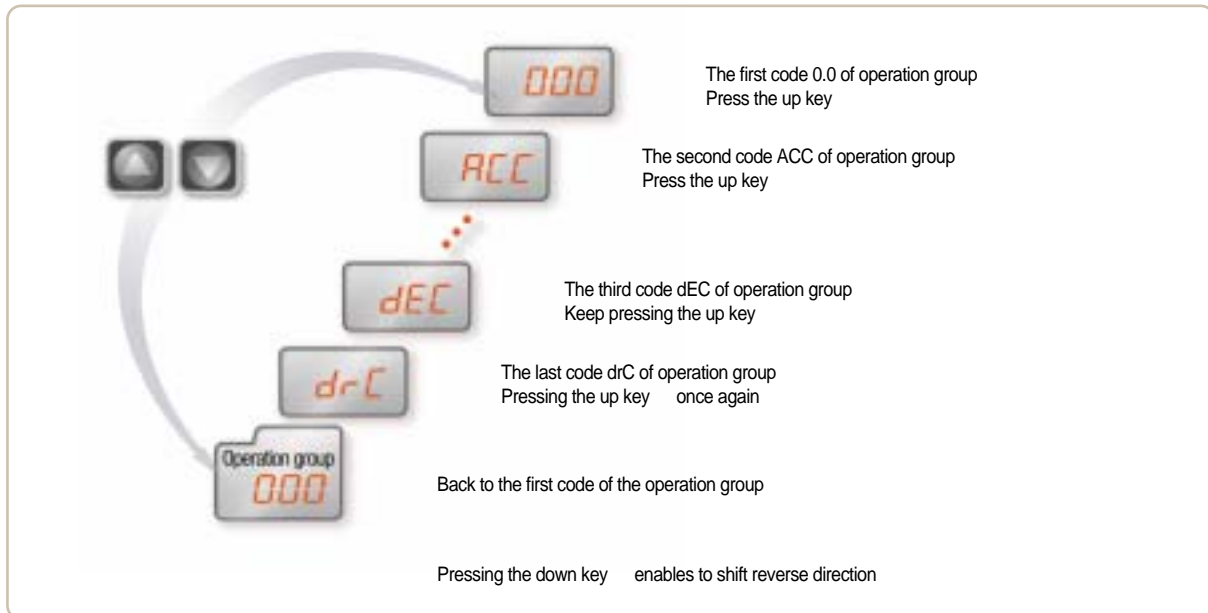

Setting the operation group frequency to 30.05Hz (Keypad operation)

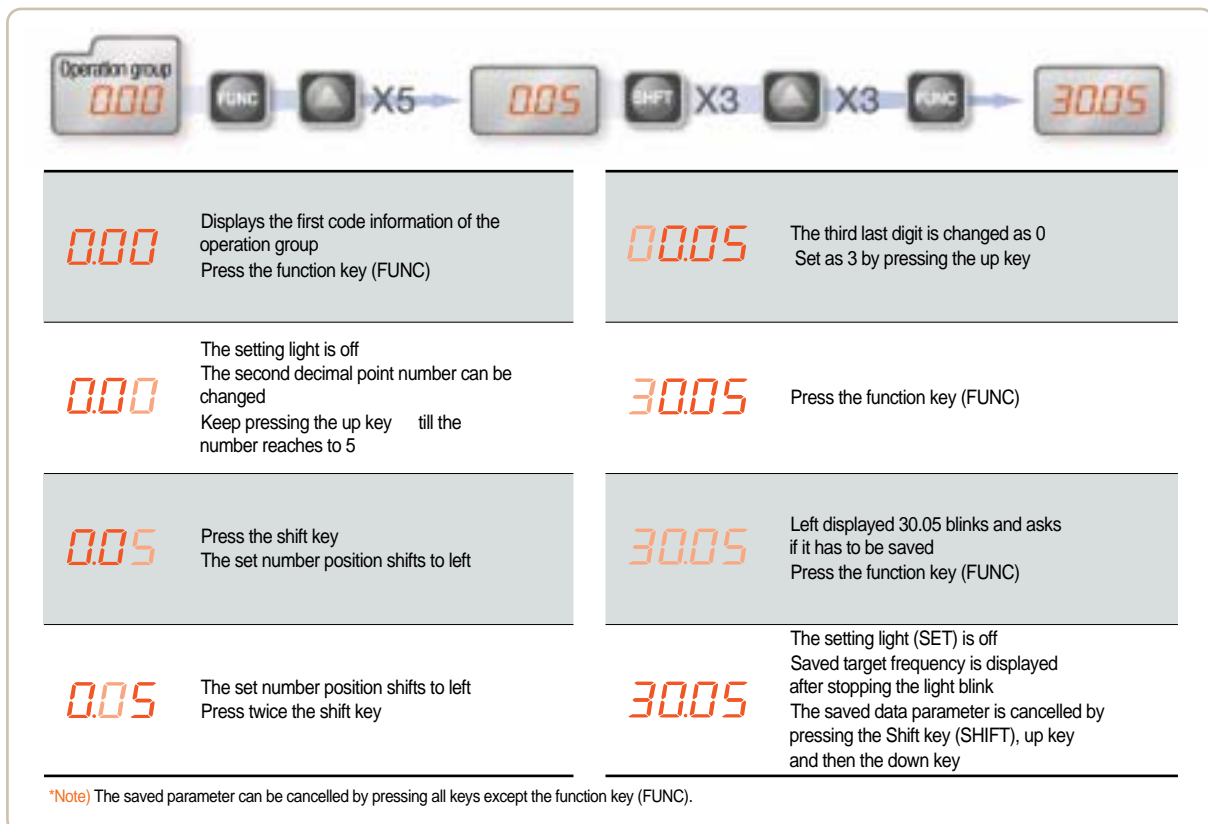



Parameter Descriptions

Operation group

Display	Function	Setting range	Description	Factory default	Mode change during run		
0.0	Command frequency	0 ~ 200 [Hz]	Operation frequency set. Displays the command frequency during stop mode and displays the output frequency during run. In case of multi-speed operation, the frequency will be zero speed. The frequency setting can not be set over the maximum frequency(P16).	0.0			
ACC	Acceleration time	0 ~ 6000 [sec]	Zero times acc/dec time in case of multi-step speed acc/dec.	5.0			
dEC	Acceleration time			10.0			
drv	Operation command method	0 ~ 3	0	Operation using the RUN key and the STOP key of loader			
			1	Terminal operation	FX : Forward operation command RX : Reverse operation command	1	x
			2		FX : Operation and Stop command RX : Selecting reverse		
			3	Communication operation: Operation by communication			
Frq	Frequency setting method	0 ~ 4	0	Digital	Loader digital frequency setting 1	0	x
			1		Loader digital frequency setting 2		
			2	Analog	Terminal AI input		
			3		Loader volume resistor		
			4		Communication option		
St1	Multi step frequency 1	0 ~ 200 [Hz]	Speed 1 frequency set in case of multi step operation	10.0			
St2	Multi step frequency 2		Speed 2 frequency set in case of multi step operation	20.0			
St3	Multi step frequency 3		Speed 3 frequency set in case of multi step operation	30.0			
CUr	Output current	-	Output current display	-	-		
rPM	No of times of motor spin	-	Displaying no of time of motor spin(RPM)	-	-		
dCL	Inverter DC voltage	-	Displaying the DC link voltage of inverter inside	-	-		
vOL	Output voltage	-	Displaying output voltage	vOL	-		
nOn	Fault status	-	Displaying the trip type, frequency, current and operation condition of trip	-	-		
drC	Spin direction selection	F, r	Setting the operation command method as 0		P		
			F	Forward operation			
			r	Reverse operation			

Program group

Display	Function	Setting range	Description	Factory default	Mode change during run	
P0	Jump code	0 ~ 88	Shifting code number set	1		
P1	Fault history 1	-	Fault type and frequency, current, acc/dec and stop condition of fault. The latest fault is saved as fault history no 1.	nOn	-	
P2	Fault history 2	-		nOn	-	
P3	Fault history 3	-		nOn	-	
P4	Fault history delete	0 ~ 1	Deleting the fault history P1~P3	0		
P5	Forward/Reverse not allowed	0 ~ 2	0	Forward/Reverse spinning is possible	0	x
			1	Forward spinning not allowed		
			2	Reverse spinning not allowed		
P6	Acceleration pattern	0 ~ 1	0	Liner pattern operation	0	x
P7	Deceleration pattern		1	S shape pattern operation		
P8	Stop mode selection	0 ~ 2	0	Deceleration stop	0	x
			1	DC braking stop		
			2	Free run stop		
P9	DC braking frequency	0.1 ~ 60 [Hz]	DC braking start frequency. DC braking frequency can not be set below the starting frequency P18.	5.0	x	

*Note1)

Parameter Descriptions

Program group

*Note1)

Display	Function	Setting range	Description	Factory default	Mode change during run																																								
P10	Output block time before DC braking	0 ~ 60 [sec]	Output is blocked for set up time and starts DC braking.	0.1	×																																								
P11	DC braking volume	0 ~ 200 [%]	DC current size that flows to motor. The standard is motor rated current (P43).	50	×																																								
P12	DC braking time	0 ~ 60 [sec]	DC time that flows to motor.	1.0	×																																								
P13	DC braking volume at ignition	0 ~ 200 [%]	DC current volume that flows to motor before it spins. Motor rated current (P43).	50	×																																								
P14	DC braking time of ignition	0 ~ 60 [sec]	DC current flows to motor for scheduled time at ignition.	0	×																																								
P15	Jog frequency	0 ~ 200 [Hz]	Jog operation frequency can be set. The frequency can not be set over maximum frequency(P16).	10.0																																									
P16	Maximum frequency	40 ~ 200 [Hz]	Frequency setting related maximum value of parameters. The standard frequency of Acc/Dec lean.	60.0	×																																								
			Note : Once the maximum frequency value is changed, all parameter values other than P17(standard frequency) are changed as the maximum frequencies that are all over the maximum frequencies.																																										
P17	Standard frequency	30 ~ 200 [Hz]	The output frequency within which the inverter output equals to the rated voltage of motor.	60.0	×																																								
P18	Starting frequency	0.1 ~ 10 [Hz]	The minimum parameter value of frequency level.	0.5	×																																								
P19	Torque boost selection	0 ~ 1	0 Manual torque boost	0	×																																								
			1 Automatic torque boost																																										
P20	Forward operation torque boost	0 ~ 15 [%]	The boost volume, in case of forward operation, that flows to motor. In case of maximum output voltage.	5	×																																								
P21	Reverse operation torque boost	0 ~ 15 [%]	The boost volume, in case of reverse operation, that flows to motor. The maximum output voltage is standard.	5	×																																								
P22	V/F pattern	0 ~ 1	0 Liner	0	×																																								
			1 Square																																										
P23	Output voltage control	40 ~ 110 [%]	Output voltage size control. The input voltage is standard.	100	×																																								
P24	Overload trip selection	0 ~ 1	Blocking the inverter output in case of overload. The overload protection function is activated if user sets as number 1.	1																																									
P25	Overload trip level	50 ~ 200 [%]	Overload current size setting. Motor rated current (P43) is standard.	180																																									
P26	Overload trip time	0 ~ 60 [sec]	Inverter blocks output if the overload trip level(P25) current flows for the overload trip time.	60																																									
P27	Stall prevention selection	0 ~ 7	Decelerating in acceleration or normal operation. Deceleration is stopped during deceleration operation.	0	×																																								
			<table border="1" style="width: 100%; text-align: center;"> <tr> <td></td> <td>Stall prevention during deceleration</td> <td>Stall prevention during normal deceleration</td> <td>Stall prevention during acceleration deceleration</td> </tr> <tr> <td></td> <td>bit 2</td> <td>bit 1</td> <td>bit 0</td> </tr> <tr> <td>0</td> <td>-</td> <td>-</td> <td>-</td> </tr> <tr> <td>1</td> <td>-</td> <td>-</td> <td>v</td> </tr> <tr> <td>2</td> <td>-</td> <td>v</td> <td>-</td> </tr> <tr> <td>3</td> <td>-</td> <td>v</td> <td>v</td> </tr> <tr> <td>4</td> <td>v</td> <td>-</td> <td>-</td> </tr> <tr> <td>5</td> <td>v</td> <td>-</td> <td>v</td> </tr> <tr> <td>6</td> <td>v</td> <td>v</td> <td>-</td> </tr> <tr> <td>7</td> <td>v</td> <td>v</td> <td>v</td> </tr> </table>				Stall prevention during deceleration	Stall prevention during normal deceleration	Stall prevention during acceleration deceleration		bit 2	bit 1	bit 0	0	-	-	-	1	-	-	v	2	-	v	-	3	-	v	v	4	v	-	-	5	v	-	v	6	v	v	-	7	v	v	v
						Stall prevention during deceleration	Stall prevention during normal deceleration	Stall prevention during acceleration deceleration																																					
						bit 2	bit 1	bit 0																																					
			0			-	-	-																																					
			1			-	-	v																																					
			2			-	v	-																																					
			3			-	v	v																																					
			4			v	-	-																																					
5	v	-	v																																										
6	v	v	-																																										
7	v	v	v																																										
0	-	-	-																																										
1	-	-	v																																										
2	-	v	-																																										
3	-	v	v																																										
4	v	-	-																																										
5	v	-	v																																										
6	v	v	-																																										
7	v	v	v																																										

*Note1) The P8 has to be set as 1 (DC braking stop)



Parameter Descriptions

Program group

Display	Function	Setting range	Description	Factory default	Mode change during run																																																																																										
P33	User selection fault detect	0 ~ 7 [bit]	Setting the fault detect item as per user selection. The input/output phase loss, ground detect during run can be selected.	0																																																																																											
			<table border="1"> <thead> <tr> <th>User selection fault detect [Trip]</th> <th>Ground detect during run GCt</th> <th>Input phase loss detect CoL</th> <th>Output phase loss detect(Pot)</th> </tr> <tr> <th></th> <th>bit 2</th> <th>bit 1</th> <th>bit 0</th> </tr> </thead> <tbody> <tr><td>0</td><td>-</td><td>-</td><td>-</td></tr> <tr><td>1</td><td></td><td></td><td>v</td></tr> <tr><td>2</td><td></td><td>v</td><td></td></tr> <tr><td>3</td><td></td><td>v</td><td>v</td></tr> <tr><td>4</td><td>v</td><td></td><td></td></tr> <tr><td>5</td><td>v</td><td></td><td>v</td></tr> <tr><td>6</td><td>v</td><td>v</td><td></td></tr> <tr><td>7</td><td>v</td><td>v</td><td>v</td></tr> </tbody> </table>			User selection fault detect [Trip]	Ground detect during run GCt	Input phase loss detect CoL	Output phase loss detect(Pot)		bit 2	bit 1	bit 0	0	-	-	-	1			v	2		v		3		v	v	4	v			5	v		v	6	v	v		7	v	v	v																																																		
			User selection fault detect [Trip]			Ground detect during run GCt	Input phase loss detect CoL	Output phase loss detect(Pot)																																																																																							
						bit 2	bit 1	bit 0																																																																																							
			0			-	-	-																																																																																							
			1					v																																																																																							
			2				v																																																																																								
			3				v	v																																																																																							
			4			v																																																																																									
5	v		v																																																																																												
6	v	v																																																																																													
7	v	v	v																																																																																												
P34	Selecting start with power input	0 ~ 1	P34 is only used in case the operation command method is selected. Either terminal number 1 or 2. Acceleration is getting started when the FX or RX terminal is on with power input.	0	×																																																																																										
P35	Selecting start after trip	0 ~ 1	P34 is only used in case the operation command method is selected either terminal number 1 or 2. In the condition that the FX and RX terminals are on, after trip, resetting starts acceleration.	0																																																																																											
P36	Speed search selection	0 ~ 15 [bit]	While motor is on spining, this function prevents the probable faults.	0																																																																																											
			<table border="1"> <thead> <tr> <th></th> <th>Starting with power input(P34)</th> <th>Restart after instant power failure</th> <th>Operation after trip (P35)</th> <th>General Acceleration</th> </tr> <tr> <th></th> <th>bit 3</th> <th>bit 2</th> <th>bit 1</th> <th>bit 0</th> </tr> </thead> <tbody> <tr><td>0</td><td>-</td><td>-</td><td>-</td><td>-</td></tr> <tr><td>1</td><td>-</td><td>-</td><td>-</td><td>v</td></tr> <tr><td>2</td><td>-</td><td>-</td><td>v</td><td>-</td></tr> <tr><td>3</td><td>-</td><td>-</td><td>v</td><td>v</td></tr> <tr><td>4</td><td>-</td><td>v</td><td>-</td><td>-</td></tr> <tr><td>5</td><td>-</td><td>v</td><td>-</td><td>v</td></tr> <tr><td>6</td><td>-</td><td>v</td><td>v</td><td>-</td></tr> <tr><td>7</td><td>-</td><td>v</td><td>v</td><td>v</td></tr> <tr><td>8</td><td>v</td><td>-</td><td>-</td><td>-</td></tr> <tr><td>9</td><td>v</td><td>-</td><td>-</td><td>v</td></tr> <tr><td>10</td><td>v</td><td>-</td><td>v</td><td>-</td></tr> <tr><td>11</td><td>v</td><td>-</td><td>v</td><td>v</td></tr> <tr><td>12</td><td>v</td><td>v</td><td>-</td><td>-</td></tr> <tr><td>13</td><td>v</td><td>v</td><td>-</td><td>v</td></tr> <tr><td>14</td><td>v</td><td>v</td><td>v</td><td>-</td></tr> <tr><td>15</td><td>v</td><td>v</td><td>v</td><td>v</td></tr> </tbody> </table>				Starting with power input(P34)	Restart after instant power failure	Operation after trip (P35)	General Acceleration		bit 3	bit 2	bit 1	bit 0	0	-	-	-	-	1	-	-	-	v	2	-	-	v	-	3	-	-	v	v	4	-	v	-	-	5	-	v	-	v	6	-	v	v	-	7	-	v	v	v	8	v	-	-	-	9	v	-	-	v	10	v	-	v	-	11	v	-	v	v	12	v	v	-	-	13	v	v	-	v	14	v	v	v	-	15	v	v	v	v
						Starting with power input(P34)	Restart after instant power failure	Operation after trip (P35)	General Acceleration																																																																																						
						bit 3	bit 2	bit 1	bit 0																																																																																						
			0			-	-	-	-																																																																																						
			1			-	-	-	v																																																																																						
			2			-	-	v	-																																																																																						
			3			-	-	v	v																																																																																						
			4			-	v	-	-																																																																																						
			5			-	v	-	v																																																																																						
			6			-	v	v	-																																																																																						
			7			-	v	v	v																																																																																						
			8			v	-	-	-																																																																																						
			9			v	-	-	v																																																																																						
			10			v	-	v	-																																																																																						
			11			v	-	v	v																																																																																						
			12			v	v	-	-																																																																																						
13	v	v	-	v																																																																																											
14	v	v	v	-																																																																																											
15	v	v	v	v																																																																																											
P37	Speed search current level	80 ~ 200 [%]	The current size during speed search operation is limited. Motor rated current(P43) is standard.	100																																																																																											
P38	Number of times of Auto-restart	0 ~ 10	Setting number of times that drive can operate automatically after trip. If trips exceed the set times, drive does not restart automatically. Only use when the operation command method(drv) of operation group is selected either terminal number 1 or 2 and the operation command is inputted. However, the Auto-restart does not work in case the protective functions such as OHT, LVT, EST and HWT are in active.	0																																																																																											
P39	Auto re-start stand by time after trip	0 ~ 60 [sec]	Re-start is operated after the auto re-start stand-by time of trip.	1.0																																																																																											
P40	Motor capacity selection	0.1 ~ 0.4		- *Note2)	×																																																																																										
P41	Number of poles of motor	2 ~ 12	Used for number of spining times of motor of the operation group.	4	×																																																																																										

*Note2) The initial value of P40 is set for the drive capacity.

Parameter Descriptions

Program group

Display	Function	Setting range	Description	Factory default	Mode change during run		
P42	Motor rating Slip frequency	0 ~ 10 [Hz]	The difference value between input power frequency and motor name plate displayed rated spin times(rpm) is inputted.	- *Note3)	×		
P43	Motor rated current	0.0 ~ 25.5 [A]	The printed rated current value of name plate is inputted.	-	×		
P44	Non-load current of motor	0.0 ~ 25.5 [A]	After taking out load from motor, the current value which was measured in operation condition of rated spin times is inputted.	-	×		
P45	Carrier frequency selection	1 ~ 10 [kHz]	As the set carrier value is larger the noise is smaller but the leaking current is bigger.	3			
P46	Control type selection	0 ~ 2	0	V/F control	0	×	
			1	Slip compensation control			
			2	PI control			
P47	PI control P gain	0 ~ 999.9 [%]	Gain setting for PI control response.	300.0			
P48	PI control I time	0.1~32.0 [sec]		1.0			
P50	PI control F gain	0 ~ 99.99 [%]	Feed forward of PI control	0.0			
P51	PI frequency highest limit	0.1 ~ 200 [Hz]	Limits the frequency size that comes from PI calculation. The setting value can be between the maximum frequency(P16) and starting frequency(18).	60.0			
P52	PI frequency lowest limit	0.1 ~ 200 [Hz]		5.0			
P53	Power input display selection	0 ~ 15	First displayed items on the loader with power input.			0	
			0	Operation frequency			
			1	Acceleration time			
			2	Deceleration time			
			3	Operation command method			
			4	Frequency command method			
			5	Multi-step frequency 1			
			6	Multi-step frequency 2			
			7	Multi-step frequency 3			
			8	Output current (Cur)			
			9	Number of times of motor spin(rpm)			
			10	Drive DC voltage (DCL)			
			11	User selection (vOL)			
			12	Fault status 1			
			13	Operation direction selection			
			14	Output current display			
15	Displaying number of times of motor spin						
P54	Gain of number of times of motor	1 ~ 1000 [%]	By calculating the gear rate of load system, displays the number of times of motor. Monitoring is possible at the (rPM) code.	100			
P55	Constant number of AI filter input	0 ~ 9999	Controlling the analog input response.	10			
P56	Minimum input of AI	0 ~ 100 [%]	Minimum analog input value can be set as % of total input.	0			
P57	AI input maximum voltage matching	0 ~ 200	Analog input minimum case frequency.	0.0			
P58	AI maximum input	0 ~ 100 [%]	The maximum analog input value can be set as all input percent(%).	100			
P59	AI input maximum voltage matching frequency	0 ~ 200 [Hz]	The maximum frequency value of analog input.	60.0			
P60	Volume input filter constant	0 ~ 9999	Response speed control of volume input operation.	10			
P61	Volume input minimum value	0 ~ 100 [%]	The volume input minimum spin value can be set as all input percent(%).	0			
P62	Volume input maximum voltage matching frequency	0 ~ 200 [Hz]	Volume input minimum value frequency.	0.0			
P63	Volume input maximum value	0 ~ 100 [%]	The volume input maximum value can be set as all input percent(%).	100			
P64	Volume input maximum voltage machine frequency	0 ~ 200 [Hz]	The volume input maximum value frequency.	60.0			
P65	Phase loss standard selection of analog speed command	0 ~ 2	0	No operation	0		
			1	Operation below half value of set			
			2	Operation below set value			

*Note3) All the values from P42 and P44 are modified to adopt the motor capacity P40.



Parameter Descriptions

Program group

Display	Function	Setting range	Description					Factory default	Mode change during run		
P66	Multi-function input terminal P1 function	0 ~ 24	0	Forward operation command(FX)					0		
			1	Reverse operation command(RX)							
P67	Multi-function input terminal P2 function		2	Emergency stop(EST-Emergency stop trip) : Temporal output block.					1		
P68	Multi-function input terminal P3 function		3	Fault reset (RST)					2		
			4	Jog operation command (JOG)							
P69	Multi-function input terminal P4 function		5	Multi-step frequency-up					3		
			6	Multi-step frequency-down							
P70	Multi-function input terminal P5 functions		7	-					4		
			8	-							
			9	-							
			10	-							
			11	DC braking command							
			12	-							
			13	-							
			14	-							
			15	Up-down operation function	Frequency up			Frequency down			
			16								
			17	3-wire operation.							
			18	External trip signal input : A contact (EtA)							
			19	External signal input : B contact (EtB)							
			20	Changing operation mode from PI to normal operation.							
21	Changing operation mode from option operation to master operation.										
22	Analog command frequency fix										
23	Acc/Dec stop command										
24	Up/Down frequency delete										
P71	Input terminal status display	BIT4	BIT3	BIT2	BIT1	BIT0	-	-			
		P5	P4	P3	P2	P1					
P72	Multi-function input filter constant	1 ~ 20	Bigger setting value resets in slower response speed.					15			
P73	Analog output item selection	0 ~ 3		Output item	Matching output 10[V]			0			
			0	Output frequency	Maximum frequency						
			1	Output current	150%						
			2	Output voltage	282V						
P74	Analog output level control	10 ~ 200 [%]	10V is standard					100			
P75	Detected frequency	0 ~ 200 [Hz]	Please use when the output terminal function of relay output(P77) is chosen from 0-4.					30.0			
P76	Detectable frequency range		No more than the maximum frequency(P16) can be set.					10.0			
P77	Multifunctional relay terminal function selection	0 ~ 17	0	FDT-1				17			
			1	FDT-2							
			2	FDT-3							
			3	FDT-4							
			4	FDT-5							
			5	Overload (OL)							
			6	Drive overload (IOLt)							
			7	Motor stall (STALL)							
			8	Overvoltage fault (OVt)							
			9	Low voltage fault (LVt)							
			10	Cooling pin overheat (OHt)							
			11	Command loss							
			12	On operation							
			13	On stop							
			14	On normal operation							
			15	Speed search function is on							
			16	Operation command is ready							
17	Fault output selection										

Parameter Descriptions

Program group

Display	Function	Setting range	Description			Factory default	Mode change during run	
P78	Fault output selection	0 ~ 7 [bit]		After trip, when the number of Auto restart is set, P38 is activated	Except low voltage trip, in all other cases this function is activated	This function is activated with low voltage trip	2	
				bit 2	bit 1	bit 0		
			0	-	-	-		
			1	-	-	v		
			2	-	v	-		
			3	-	v	v		
			4	v	-	-		
			5	v	-	v		
6	v	v	-					
7	v	v	v					
P79	Drive channel	1 ~ 250	Use with communication option			1		
P80	Communication speed	0 ~ 2	Communication speed set			2		
			0	2400 [bps]				
			1	4800 [bps]				
			2	9600 [bps]				
P81	Operation type selection when the speed command is lost	0 ~ 2	This function is used when the analog signal of terminal (Volume or AI) or communication are operated by frequency command.			0		
			0	Operating before command loss frequency				
			1	Free run stop (Blocking output)				
			2	Deceleration stop				
P82	Speed command loss determination time	0.1 ~ 120 [sec]	If the frequency command is not inputted during speed command loss determination time the drive is operated by P81 selected operation way.			1.0	-	
P83	Communication stand-by time	2 ~ 100 [ms]	In case of RS 485 communication, setting the stand-by time to the next TX output after TX signal.			5		
P84	Parity/STOP setting	0 ~ 3	Communication parity and STOP bit are set like following.			0		
				Parity bit	Stop bit			
			0	-	1 Stop bit			
			1	-	2 Stop bit			
			2	Odd Parity	1 Stop bit			
3	Even Parity	1 Stop bit						
P85	Parameter Initializing	0 ~ 3	User modified parameters can be initialized as factory default values.			0	x	
			0	-				
			1	2 Groups' parameters initialization				
			2	Operation groups' parameters initialization				
3	Program group parameters initialization							
P86	Password registration	0 ~ FFFF	Password inputted to prohibit the parameter change and values are set as HEXA.			0		
P87	Parameter change prohibition	0 ~ FFFF	The parameter change prohibition can be executed or cleared by the password.			0		
			UL(Unlock)	Parameter change is allowed				
			L(Lock)	Parameter change is prohibited				
P88	Version of Software	-	Displays the SW version of drive. Please refer to the manual version.			-	x	



Protections

Display	Protections	Descriptions
OCt	Over current	Drive output is blocked in case the output current is over 200% of rated current.
GFt	Ground current	In case the ground protection of starting point is used, the drive output is blocked if ground current flows that is generated from the drive output side.
GCE	Ground current	Drive blocks its output if the over current is flowed to any phase of between U.V.W phase. In this case the over current is generally generated by unbalancing from ground fault.
IOl	Overload	If the output current of drive is over 150% of rated current for more than one minute, the output is blocked. The protection time is shortened as output current is increased
OLt	Overload trip	If output current is bigger than motor rated current(P25) the output is blocked
OHt	Cooling fan overheat	If the drive cooling fan is overheated, and if the ambient temperature of drive reaches to over recommended degree, the output of drive is blocked.
COL	Condenser overload	This fault is generated in case of single phase loss of three phase product or if DC voltage fluctuation level becomes big as the main condenser is aged. Yet the condenser overload detection time can be varied depend on the output current size.
POt	Output loss	More than one phase becomes loss among U.V.W, the drive output is blocked.
OVt	Over voltage	If the main circuit DC voltage of drive inside goes over 400V, the output is blocked. This over voltage is generated if the deceleration time is too short or the input voltage goes over recommended level.
LVt	Low voltage	If drive inside main circuit voltage goes below 180V, drive blocks its output.
EEP	Parameter save fault	When the changed parameter is inputted to drive, if some faults are generated, this fault is displayed. This is displayed with power input.
HOt	Hardware fault	This is displayed with CPU or OS fault. This is not cleared by the STOP/RST key of loader or by the reset terminal. Fault is not cleared by STOP/RST keys of the keypad or reset terminal. Please re-input power after off the drive power and the keypad display power is completely off.
EST	Output instant blocking	Drive output is blocked when the EST terminal is on.  Caution : with the " ON " of terminal operation command signal FX or RX, if the EST terminal is off drive restart its operation.
EtA	A Contact fault signal input	Once the multi-function input terminal selection(P66~P70) is selected as number 18(External trip signal input : A contact) and if this selected becomes "OFF" the drive blocks output.
EtB	A Contact fault signal input	Once the multi-function input terminal selection(P66~P70) is selected as number 19(External trip signal input : B contact) and if this selected becomes "OFF" the drive blocks output.
---L	Frequency phase loss	Displays fault status of frequency command. In case the analog input(0~10V), 0~20mA and option(RS485)operation, if the operational signal is not inputted, the operation is carried out by P81 that is selected from the speed command phase loss operation.

Check and Remedy

Protections	Fault reason	Remedy
 Caution The fault caused by over current may damage drive inside power semiconductor parts so that the reason of over current has to be cleared first and then start operation.		
OCt Over current	Acc/Dec time is too fast comparing to the load inertia(GD2) Load is bigger than rated value. Drive output is released during free run of motor. Output terminal and ground fault. Motor breaking is too speedy.	Please set the Acc/Dec time with higher margin. Please replace bigger capacity drive. Try to operate after stopping motor or please use the speed search function(H22) of function group 2. Please check the output wiring. Please check the mechanical break.
GFt GCt Ground current	Drive output cable is on ground fault. Motor insulation is heated.	Please check the output terminal wiring. Please replace the motor.
IOt OIt Drive overload Overload trip	Load is bigger than rated value. Torque boost volume is too big.	Please use higher capacity motor and drive. Please reduce the torque boost volume.
OHE Cooling fan overheat	Cooling system fault. Cooling fan lifetime is over. High ambient temperature.	Please check the vents. Please replace cooling fan. Please keep the ambient temperature to 40 .
COL Condenser overload	1 phase is loss of three phase product. Internal condenser life is over.	Please check input power wiring. Please check the input power. Replacement may need please ask after sales service.
POt Output phase loss	Electronic contactor fault of output part. Output wiring fault.	Please check the electronic contactor of output part. Please check the output part wiring.
Ovt Over voltage	Dec time is too short comparing to the load inertia(GD2). Regenerative load is located at the output part. Main power is to high.	Please set the deceleration time with higher margin. Please down the main power below rated value.
Lvt Low voltage	Main power is too low. Bigger than power capacity load is contacted to the main power part. Electronic contactor fault of power part.	Please use over rated value power. Please use higher power. Please replace the electronic contactor.
EA A contact fault signal input EB B contact fault signal input	When the multi-function input terminal selection of the program group(P66-P70) is set as number 18 or 19 if these terminals are "ON" these fault messages are displayed.	Circuit fault and external faults.
--- Frequency command loss	No command at the V1 and I terminals. No signal input of communication option.	Please check the wiring and command level of V1 and I terminals. Please check the communication cable of the master device.
EEP Parameter save fault	HWt Hardware fault	After software upgrade when the power is inputted as first time, these messages are displayed. In this case, please "OFF" the power first and then re-input the power. This is normal operation after software upgrade.



Peripheral device specifications

MCCB and MC standards

Drive capacity	MCCB(LSIS)		ELCB(LSIS)		MC(LSIS)	
001 IE5-1	ABS33b	5A	EBS33b	5A	GMC-9	7A
002 IE5-1		10A		10A	GMC-12	9A
004 IE5-1		15A		15A	GMC-18	13A
001 IE5-2		3A		3A	GMC-9	7A
002 IE5-2		5A		5A	GMC-9	7A
004 IE5-2		10A		10A	GMC-12	9A

Reactor specification

Drive capacity	AC input fuse	AC reactor	DC reactor
001 IE5-1	5A	4.2mH, 3.5A	10mH, 3A
002 IE5-1	5A	4.2mH, 3.5A	10mH, 3A
004 IE5-1	10A	5.1mH, 5.4A	7mH, 5A
001 IE5-2	5A	4.2mH, 3.5A	10mH, 3A
002 IE5-2	5A	4.2mH, 3.5A	10mH, 3A
004 IE5-2	5A	4.2mH, 3.5A	7mH, 5A

Dimension

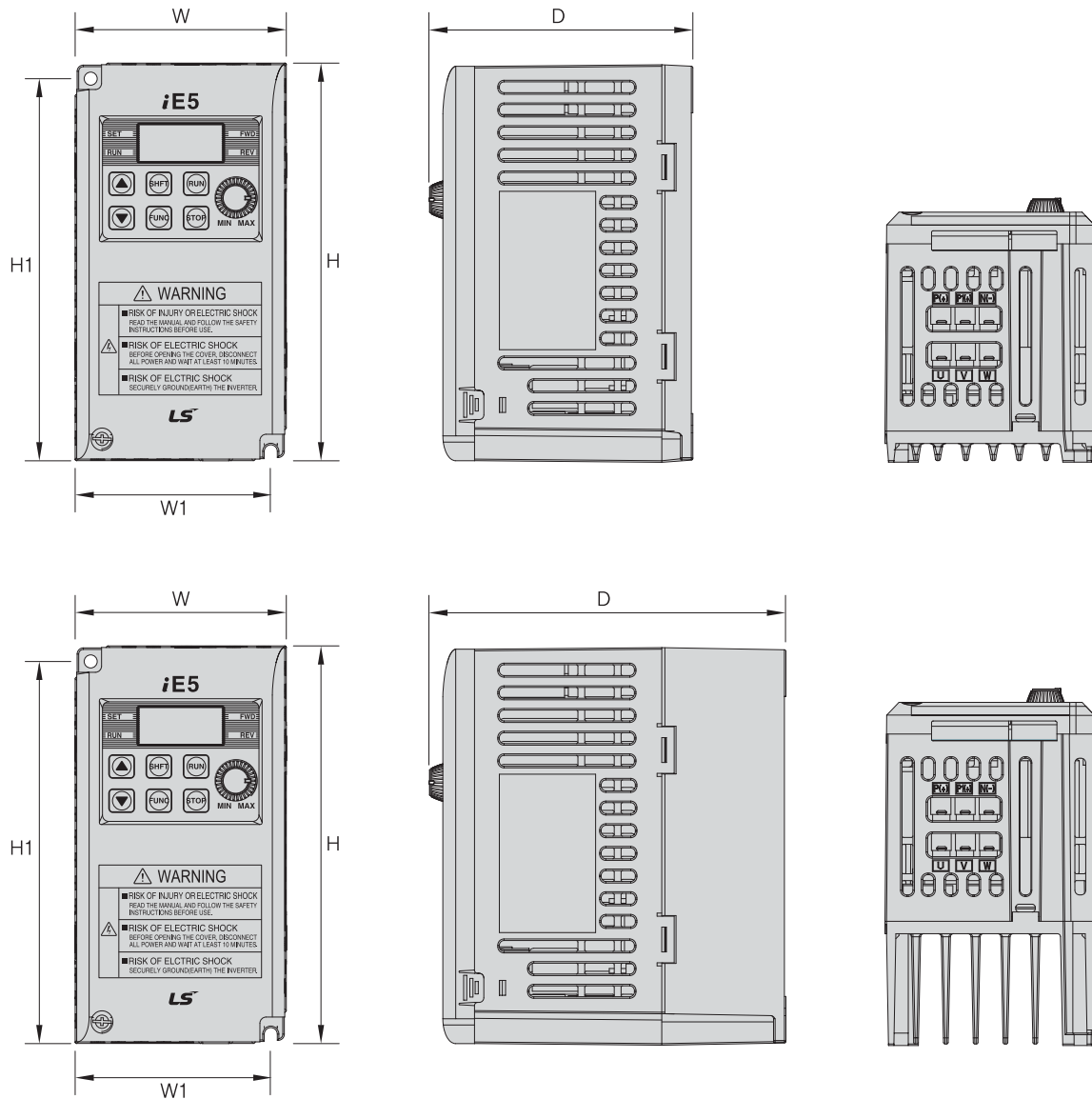

Measure	001 iE5-1	002 iE5-1	004 iE5-1	001 iE5-2	002 iE5-2	004 iE5-2
W	68	68	68	68	68	68
H	128	128	128	128	128	128
D	85	85	115	85	85	115
H1	124	124	124	124	124	124
W1	64	64	64	64	64	64
	4.2	4.2	4.2	4.2	4.2	4.2

*Note) Please use the M4 bolt in case this drive is installed into the panels.



Memo

A large, empty rectangular area with a light blue gradient background, intended for writing a memo.

Memo

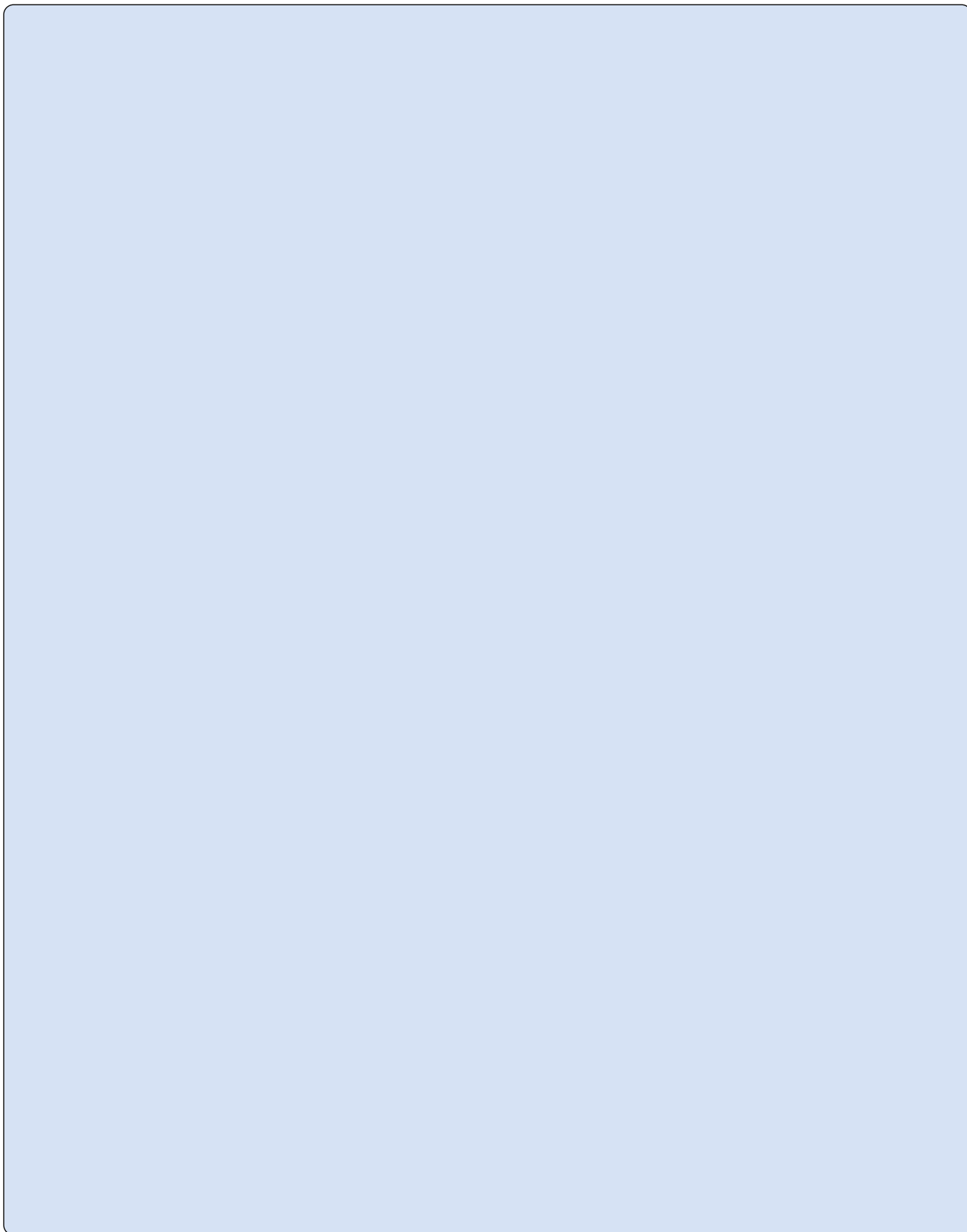

Green Innovators of Innovation



Safety Instructions

- For your safety, please read user's manual thoroughly before operating.
- Contact the nearest authorized service facility for examination, repair, or adjustment.
- Please contact qualified service technician when you need maintenance. Do not disassemble or repair by yourself!
- Any maintenance and inspection shall be performed by the personnel having expertise concerned.

© 2003.2 LS Industrial Systems Co.,Ltd. All rights reserved.

LS Industrial Systems Co., Ltd.

www.lsis.biz

■ HEAD OFFICE

LS Tower 1026-6, Hoge-dong, Dongan-gu,
Anyang-si, Gyeonggi-do 431-848, Korea

- **Asia Pacific & America** +82-2-2034-4901 / bonseongk@lsis.biz
- **Europe & CIS** +82-2-2034-4376 / ywsohn@lsis.biz
- **Meddle East & Africa** +82-2-2034-4645 / sungkyup@lsis.biz

■ Global Network

- **LS Industrial Systems Europe B.V.** >> **Amsterdam, Netherlands**
Address: 1st Floor, Tupolevlaan 48, 1119NZ Schiphol-Rijk, The Netherlands
Tel: 31-20-654-1420 Fax: 31-20-654-1429 e-mail: junshickp@lsis.biz
- **LS Industrial Systems (Middle East) FZE** >> **Dubai, U.A.E.**
Address: LOB 19 JAFZA VIEW TOWER Room 205, Jebel Ali Freezone P.O. Box 114216, Dubai, United Arab Emirates
Tel: 971-4-886 5360 Fax: 971-4-886-5361 e-mail: jungyongl@lsis.biz
- **Dalian LS Industrial Systems Co., Ltd.** >> **Dalian, China**
Address: No.15, Liaohexi 3-Road, Economic and Technical Development zone, Dalian 116600, China
Tel: 86-411-8273-7777 Fax: 86-411-8730-7560 e-mail: lixx@lsis.com.cn
- **LS Industrial Systems (Wuxi) Co., Ltd.** >> **Wuxi, China**
Address: 102-A, National High & New Tech Industrial Development Area, Wuxi, Jiangsu, 214028, P.R.China
Tel: 86-510-8534-6666 Fax: 86-510-522-4078 e-mail: xuhg@lsis.com.cn
- **LS-VINA Industrial Systems Co., Ltd.** >> **Hanoi, Vietnam**
Address: Nguyen Khe - Dong Anh - Ha Noi - Viet Nam
Tel: 84-4-882-0222 Fax: 84-4-882-0220 e-mail: srjo@lsisvina.com
- **LS-VINA Industrial Systems Co., Ltd.** >> **Hochiminh, Vietnam**
Address: 41 Nguyen Thi Minh Khai Str. Yoco Bldg 4th Floor, Hochiminh City, Vietnam
Tel: 84-8-3822-7941 Fax: 84-8-3822-7942 e-mail: sbpark@lsisvina.com
- **LS Industrial Systems Tokyo Office** >> **Tokyo, Japan**
Address: 16FL, Higashi-Kan, Akasaka Twin Tower 17-22, 2-chome, Akasaka, Minato-ku Tokyo 107-8470, Japan
Tel: 81-3-3582-9128 Fax: 81-3-3582-2667 e-mail: jschuna@lsis.biz
- **LS Industrial Systems Shanghai Office** >> **Shanghai, China**
Address: Room E-G, 12th Floor Huamin Empire Plaza, No.726, West Yan'an Road Shanghai 200050, P.R. China
Tel: 86-21-5237-9977 (609) Fax: 89-21-5237-7191 e-mail: jinhk@lsis.com.cn
- **LS Industrial Systems Beijing Office** >> **Beijing, China**
Address: B-Tower 17FL, Beijing Global Trade Center B/D, No.36, BeiSanHuanDong-Lu, DongCheng-District, Beijing 100013, P.R. China
Tel: 86-10-5825-6025,7 Fax: 86-10-5825-6026 e-mail: cuixiaorong@lsis.com.cn
- **LS Industrial Systems Guangzhou Office** >> **Guangzhou, China**
Address: Room 1403,14F, New Poly Tower, 2 Zhongshan Liu Road, Guangzhou, P.R. China
Tel: 86-20-8326-6764 Fax: 86-20-8326-6287 e-mail: linsz@lsis.biz
- **LS Industrial Systems Chengdu Office** >> **Chengdu, China**
Address: Room 1701 17Floor, huanminhanjun international Building, No1 Fuxing Road Chengdu, 610041, P.R. China
Tel: 86-28-8670-3101 Fax: 86-28-8670-3203 e-mail: yanggf@lsis.com.cn
- **LS Industrial Systems Qingdao Office** >> **Qingdao, China**
Address: 7B40, Haixin Guangchang Shenye Building B, No.9, Shandong Road Qingdao 26600, P.R. China
Tel: 86-532-8501-6568 Fax: 86-532-583-3793 e-mail: lirj@lsis.com.cn

Specifications in this catalog are subject to change without notice due to continuous product development and improvement.